

CALIMA

- Robustness and dimensional stability - maximum reliability, even under demanding installation conditions
- Bis zu 30 % leichter - Weil der Transport, das Handling und die Montage einfach leichter sein sollten
- Class C slip resistance - maximum safety as standard thanks to INVISIBLE GRIP
- Sound-insulating - for a quiet, pleasant shower experience
- Can be cut at the factory - adapts flexibly to any installation situation. Please contact us and we will customise your shower to your individual dimensions

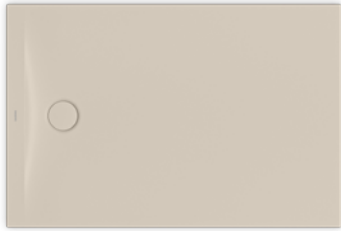

Similar illustration

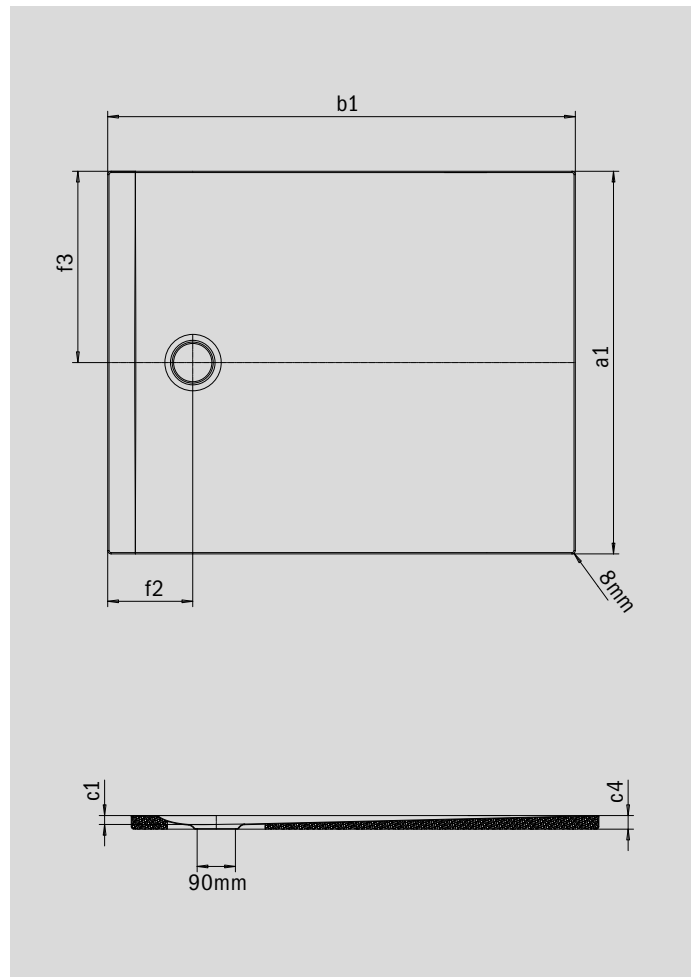

Model		3228
External length [mm]	a_1	800 mm
External width [mm]	b_1	1300 mm
Depth inside [mm]	c_1	20 mm
Height of rim [mm]	c_4	32 mm
Height with support [mm]	c_{10}	32 mm
Diameter of waste hole [mm]	f_9	Ø 90 mm
Distance bath edge to centre of waste hole [mm]	f_2, f_3	200; 400 mm
External radius [mm]	r_1	8 mm
Net weight [kg]		27 kg