

# CALIMA

- Robustness and dimensional stability - maximum reliability, even under demanding installation conditions
- Bis zu 30 % leichter - Weil der Transport, das Handling und die Montage einfach leichter sein sollten
- Class C slip resistance - maximum safety as standard thanks to INVISIBLE GRIP
- Sound-insulating - for a quiet, pleasant shower experience
- Can be cut at the factory - adapts flexibly to any installation situation. Please contact us and we will customise your shower to your individual dimensions

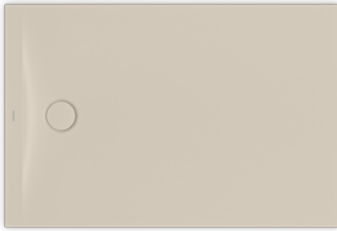

Similar illustration

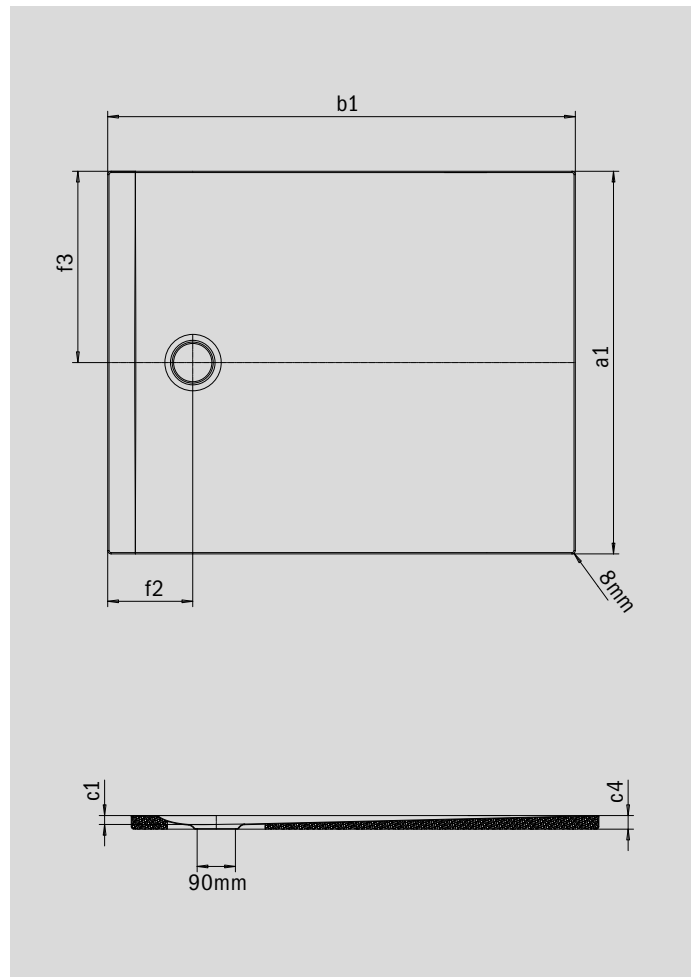

Model		3226
External length [mm]	$a_1$	700 mm
External width [mm]	$b_1$	1300 mm
Depth inside [mm]	$c_1$	20 mm
Height of rim [mm]	$c_4$	32 mm
Height with support [mm]	$c_{10}$	32 mm
Diameter of waste hole [mm]	$f_9$	Ø 90 mm
Distance bath edge to centre of waste hole [mm]	$f_2, f_3$	200; 350 mm
External radius [mm]	$r_1$	8 mm
Net weight [kg]		23 kg